

aerospace  
climate control  
electromechanical  
filtration  
fluid & gas handling  
hydraulics  
pneumatics  
process control  
sealing & shielding

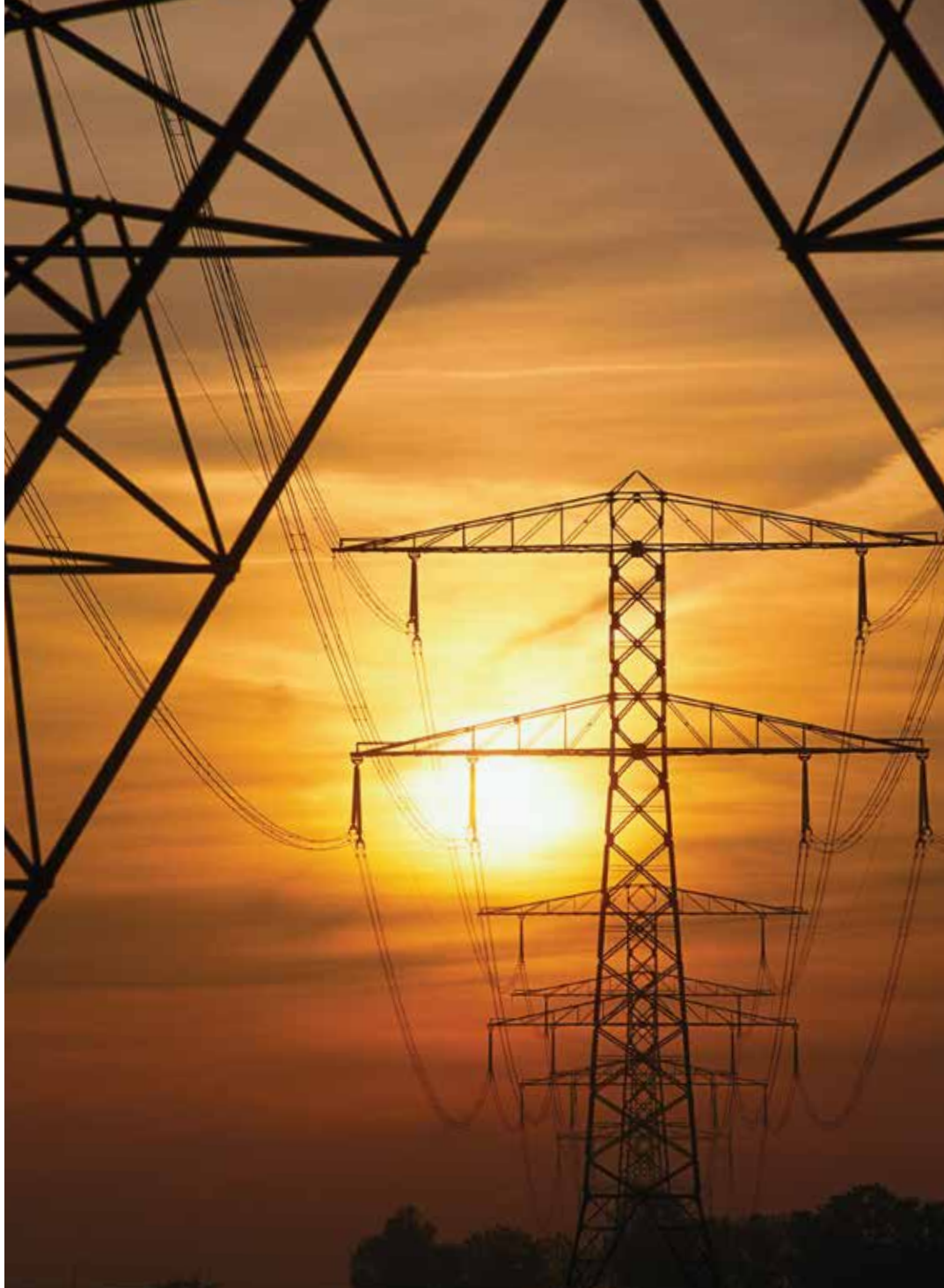

# Power Generation

Empowering innovation worldwide



ENGINEERING YOUR SUCCESS.

# Energizing the energy business

Advanced technologies and systems that deliver the availability, flexibility, sustainability, reliability, and profitability you need.

## AVAILABILITY:

WORLDWIDE. AND WORLD RENOWN.

With 50,000 employees serving 500,000 customers in almost 50 countries, Parker is literally everywhere you need us to be. By working with us, you have access to an integrated network of 316 manufacturing plants, 13,000 distributors and MRO outlets, and over 1,500 ParkerStores. Not only that: our technicians and market-specific engineers are ready to help you with system or subsystem design, on-site or off.



## FLEXIBILITY:

SYSTEMS THAT OPTIMIZE VALUE

As the world's motion control expert, Parker offers you a complete range of proven, off-the-shelf products. Engineered to work together, these products deliver streamlined systems and subsystems with exceptional quality and durability. Whether for geothermal, wind, and solar ... or nuclear, fossil fuel, gas turbine, and combined cycle plants ... our system solutions reduce costs and advance performance. Cleanly. Efficiently. And reliably.

Want to know more about wind power and other emerging technologies? Call 1-800-C-Parker. International customers call 00800 27 27 5374.

## SUSTAINABILITY:

PROTECTING PEOPLE AND ENVIRONMENT

Parker can help you meet the need for fuel-efficient, low-emission, high-performance energy. Our advanced technologies and innovations improve emissions performance, minimize waste, meet environmental regulations, monitor air and water quality, offer longer life, and help create greater fuel efficiency.

## PROFITABILITY:

LEAN AND CONTINUOUS

At Parker, we actively seek new and better ways to do things as part of our mandate for continuous improvement. Committed 100% to total support, we partner with our customers to focus on creating solutions that are smaller, lighter, more energy efficient, and highly reliable, as well as cost effective. And we offer services that reduce outage times and operational costs, such as:

- **Custom kits:** With materials organized by order and quantity, these single part-number kits streamline procedures, reduce assembly time, and lower costs.
- **An international network of support facilities:** To meet emergency needs and reduce downtime.
- **Vendor-managed inventory:** Including custom-tailored bin-filling programs managed by us.



## RELIABILITY:

NATIONAL AND INTERNATIONAL CERTIFICATIONS

Our certifications verify that our systems and solutions offer the highest possible quality for the most efficient performance. These include:

- **ASME:** Codes and standards set by the American Society of Mechanical Engineers.
- **ATEX:** Covering equipment operating in mines or potentially explosive gas, vapor, or air/dust environments.
- **B31.1/B31.3:** Certifying process and power piping.
- **CE:** Indicating that a product has met EU consumer safety, health, or environmental requirements.
- **CSA/CRN:** Shows product has been tested and meets applicable national standards in the U.S. and/or Canada.

**FM:** Assures customers a product or service has been tested and conforms to the highest national and international standards.

**N Stamp:** Quality assurance of construction materials, design, operation, inspection, and continuing maintenance of nuclear facilities.

**PED:** Certifying pressure equipment and assemblies.

**PM:** Globally recognized certification of project management expertise.

**UL:** An independent product safety certification.





## COMBUSTION TURBINE

Parker has been at the forefront of combustion turbine technology from the earliest high-performance jet engines to today's most demanding power generation applications. Over five decades of experience have given us wide ranging expertise in systems and components for fuel and water atomization, fuel controls, emission controls, and condition monitoring ... all driving turbine efficiency rates. By working with Parker, you'll benefit from sustained engine performance with higher MW output, the lowest maintenance costs, extended engine and component life, reduced operating costs, and lower emissions due to greater fuel-burning efficiency.



### How Parker drives power conversion



The SSD Drives division manufactures electric power conversion systems including variable speed drives for AC, DC, and servo motors, and grid tie inverters. Applications for drives include variable speed blowers, ID and FD fans, cooling towers, pumps, and compressors. Other capabilities include synchronous generator field supplies and electric starting systems for gas turbines. Grid tie inverters are used extensively in wind, wave, and solar power generation. SSD power conversion systems are also used in spinning reserve systems, grid frequency stabilization, and peak shaving applications, efficiently linking battery storage to the grid. In addition, Parker power conversion systems can provide KVAR compensation for optimization of power factor.

### SILOXANE REMOVAL:

#### Improving the profitability of biogas-to-energy projects

Biogas generated in landfills and wastewater digesters contains siloxane – a man-made chemical that changes into silicon dioxide (sand) when combusted. When landfill and digester gas are used to fuel turbines, reciprocating engines, and fuel cells that generate electricity, silicon dioxide build-up due to siloxane significantly increases maintenance costs, reducing the feasibility of these important green energy projects. Parker's GES Siloxane Removal System removes siloxanes from biogas, reducing maintenance costs, improving profitability, and ultimately making more of these projects cost-effective. Parker also provides advanced biogas chilling systems and filters to further treat and clean biogas used for power generation. Look to Parker for innovative solutions and filtration protection.



# Power Source: COMBUSTION TURBINE

Better combustion for cleaner-burning engines.

Look to Parker for:

- 1 Filtration, lubrication, and condition monitoring
- 2 Emissions reduction
- 3 High-temperature metal seals
- 4 Fuel control and delivery systems
- 5 Inlet fogging system
- 6 Wet compression system
- 7 Continuous emission monitoring systems (CEMS)
- 8 Expansion joints

**Filtration, lubrication, and condition monitoring**  
Complete filtration, lubrication, and condition monitoring system prevents damage to bearings, double-checks filter operation, and monitors gearbox oil for particulate and water content.

*Pictured: SMR (Sub-Micron Removal) system (right); portable on-line particle counter (below).*

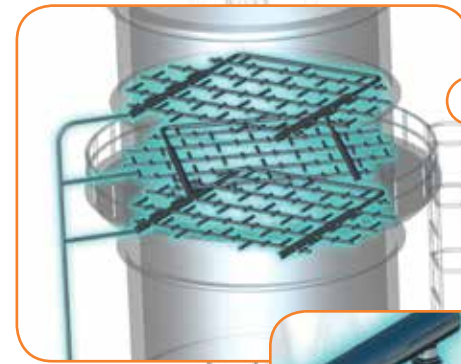

**Emissions reduction**  
Parker nozzle technology can help reduce NO<sub>x</sub> and CO from turbine exhaust.

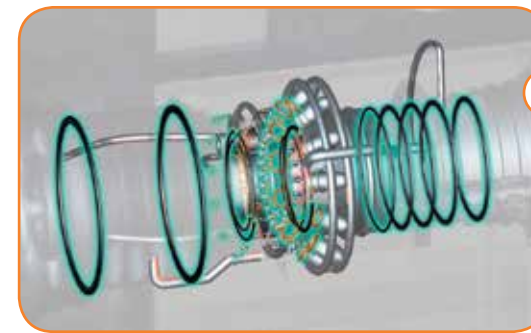

**High-temperature metal seals**  
Improve turbine efficiency.



**Fuel control and delivery systems**  
Fuel oil and fuel gas control systems drive industry-low NO<sub>x</sub> emissions while improving gas turbine efficiencies. Clean, check and test (CCT) services for nozzles are available.  
*Pictured: fuel nozzles (left); fuel control system (center); water injection system (right).*

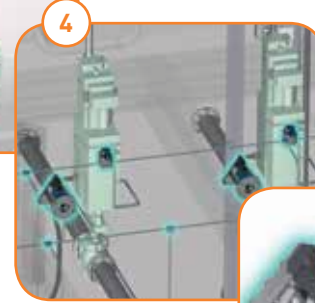

**Inlet fogging system**  
Utilizes patented Macrospray® single point nozzles for the highest MW power augmentation in the industry.



**Wet compression system**  
Uses high-pressure stainless steel filters, valves, code flanges, fittings, and patented Macrospray® spider nozzles to uniformly spray finely atomized demineralized water into the compressor inlet. This decreases workload on the compressor and produces turbine power gains, improved heat rate, and reduced NO<sub>x</sub> levels in a highly reliable and cost-effective evaporative cooling system.



**Expansion joints**  
Long-lasting performance for applications up to 1,800°F (982°C) on gas turbine inlet, exhaust, and HRSG systems.

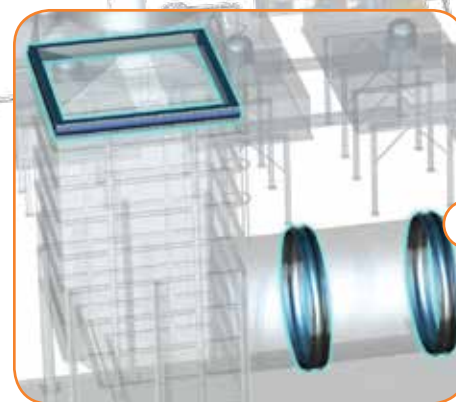

**Continuous emission monitoring systems (CEMS)**  
Our control panels and gas conditioning and delivery systems (stainless steel pigtails, pressure regulators, filters, and manifold systems) help provide accurate determination of gas emission levels to ascertain whether the engine is operating within compliance parameters.

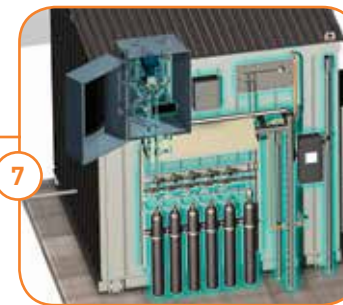

## COMBUSTION TURBINE

# ENGINEERED SOLUTIONS



### >> CB CHECK VALVES PREVENT COKING

**Problem:**  
When dual fuel combustion turbines run on fuel oil (diesel fuel), high temperatures can “cook” the fuel oil, leading to coke formations in the fuel lines and check valve locations. Once the check valve is “coked up” or sticky, it won’t operate properly, leading to uneven fuel distribution, hot spots, or failure to fire – problems that result in turbine trips or false starts.

**Solution:**  
Parker check valves reduce coke deposits and buildup by using high-temperature sealing materials of “non-stick” carbon-graphite and carbon-reinforced Teflon®, as well as a floating ball design inside the check valve.

**Parker Advantage:**  
Field proven, best-performing, and longest-lasting air, water injection, and liquid fuel check valves in the industry. Designs for all OEM gas turbine applications.

Teflon® is a registered trademark of DuPont.



### >> ICount BOTTLE SAMPLER FOR CLEANLINESS MONITORING

**Problem:**  
Critical hydraulic and lubrication systems require continuous monitoring to ensure proper cleanliness levels.

**Solution:**  
Parker’s icount bottle sampler offers continuous monitoring with visual and electrical notification of oil cleanliness levels.

**Parker Advantage:**  
Units are programmable with user ISO cleanliness levels; trending software included.



### >> SMR SYSTEM FOR VARNISH REMOVAL

**Problem:**  
Varnish buildup in hydraulic fluid.

**Solution:**  
SMR (Sub-Micron Removal) off-line filtration system.

**Parker Advantage:**  
Parker’s SMR system contains patent-pending Balanced Charge Agglomeration (BCA™) technology to maintain hydraulic and lubricating fluids in optimum condition and prevent/remove the buildup of sludge and varnish.



### >> ABEX SERVOVALVES ELIMINATE TURBINE TRIPS

**Problem:**  
Oil varnish causes servos to go “hard over,” resulting in costly turbine trips.

**Solution:**  
Parker ABEX Jet-Pipe® servovalves are a fail-to-center design.

**Parker Advantage:**  
Parker servos can pass up to a 200 micron particle and have the highest performance aerospace design for the longest life.



### >> HYDRAULIC POWER UNIT FOR SINGLE-SOURCE EFFICIENCY

**Problem:**  
Multiple suppliers for HPU components result in extended lead times and poor product support, creating operational inefficiencies.

**Solution:**  
Parker – a single source for complete HPU packages.

**Parker Advantage:**  
Parker HPUs provide an integrated package that includes filters, hoses and fittings, pumps, valves, manifolds, accumulators, and both in-line and off-line particulate, water, and varnish removal. A one-stop shop, we can supply individual components, a subsystem, or the entire HPU.



### >> SENSO CONTROLS FOR DATA COLLECTION

**Problem:**  
Data collection of pressures, temperatures, and flows in potential problem spots around the turbine.

**Solution:**  
Parker Senso Controls data collection system allows for quick, easy, portable collection of data.

**Parker Advantage:**  
Simple, affordable, accurate, and adaptable system.



## COMBINED CYCLE

No matter how your combined cycle plant operates – base load, simple cycle, seasonally, or peaking – Parker has everything you need to keep it running at optimum efficiency. Our combined cycle applications include systems, subsystems, and components that work throughout the plant to reduce emissions, lower maintenance costs, preserve plant and component life, and improve turbine efficiency. From hydraulics and pneumatics to electromechanical, instrumentation, filtration, sealing, emissions controls, fluid connections, and HMI, you can turn to Parker for solutions that will meet and exceed both your specifications, and your expectations.

### New technologies

HMI solutions for plant control systems and monitoring

The drive toward open solutions and PC-based machine control is fueling a revolution on the plant floor – a revolution Parker is well prepared for. Offering a full range of hardware and software HMI solutions with the connectivity and expandability of an open platform, our integrated touch-screens, industrially-hardened workstations, and software packages focus on meeting the needs of the power plant with products that offer real-time response, high reliability, deterministic control, and ease of development and support.



### Highest performing fuel and fog nozzles

Derived from Parker aerospace technology, our patented Macrospray® nozzles offer the highest performance in the industry, driving the lowest NO<sub>x</sub> emissions and improving gas turbine efficiencies through improved fuel flow, atomization, better combustion, and lower installed and lifecycle costs.



# Power Source: COMBINED CYCLE

Systems, subsystems, and components that improve plant efficiency in all operating modes.

Look to Parker for:

- 1 Steam blowdown assembly
- 2 Nitrogen generators
- 3 Expansion joints
- 4 Diverter damper controls
- 5 Fuel and air control
- 6 Hydraulic power unit
- 7 Hydraulic cylinders
- 8 Hydraulic lift oil pump
- 9 Liquid fuel filtration

**Nitrogen generators**  
Our nitrogen generators for HRSG and boiler tubes limit corrosion during lay-ups, extending plant and component life.

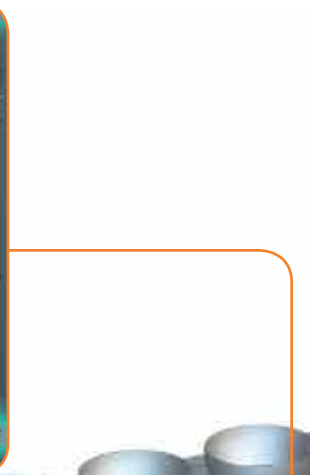

**Expansion joints**  
Applicable on gas turbine inlet, exhaust, and HRSG systems, our expansion joints offer longer-lasting performance for applications up to 1,800°F (982°C).

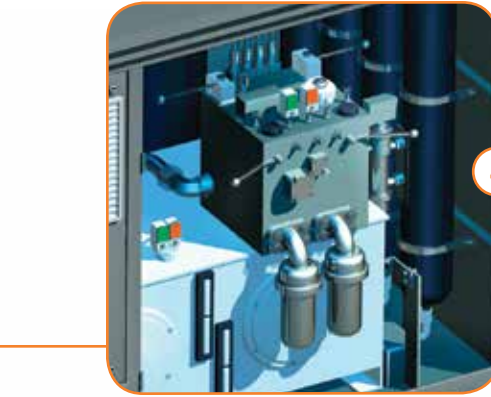

**Diverter damper controls**  
Specialty gas turbine hydraulic components and systems provide high-speed, high-accuracy diverter damper controls, fuel controls, and turbine controls.

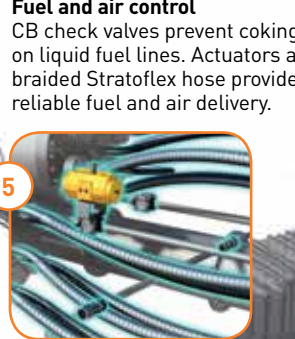

**Fuel and air control**  
CB check valves prevent coking on liquid fuel lines. Actuators and braided Stratoflex hose provide reliable fuel and air delivery.

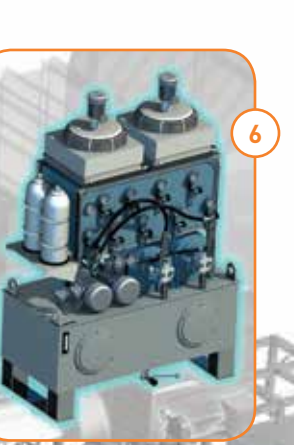

**Hydraulic power unit**  
Parker power units provide reliable, high-speed, and precise control for turbine fuel control valves, inlet guide vane actuation, and even steam turbine EHC systems.

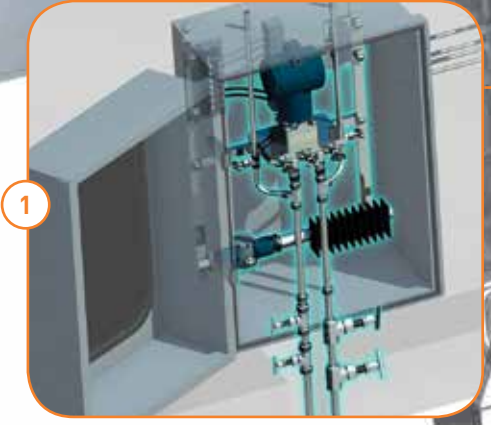

**Steam blowdown assembly**  
High-temperature steam blowdown and control valves offer industry-leading safety and reliability. B31.1 certification available on valves and manifolds.

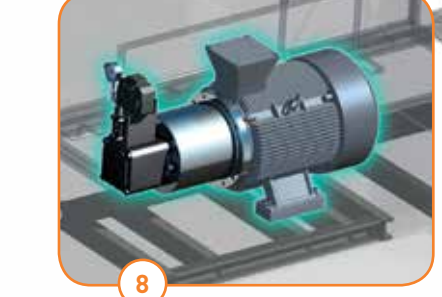
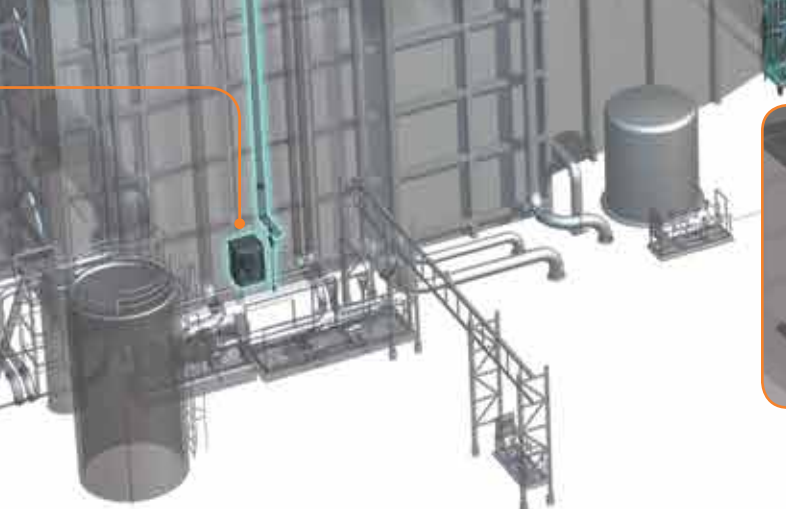

**Hydraulic cylinders**  
Our hydraulic cylinders are completely customized to varying diverter sizes to provide the optimum design for specific applications.

**Hydraulic lift oil pump**  
Industry-leading lift oil pump provides reliable lubrication to maximize journal bearing life.

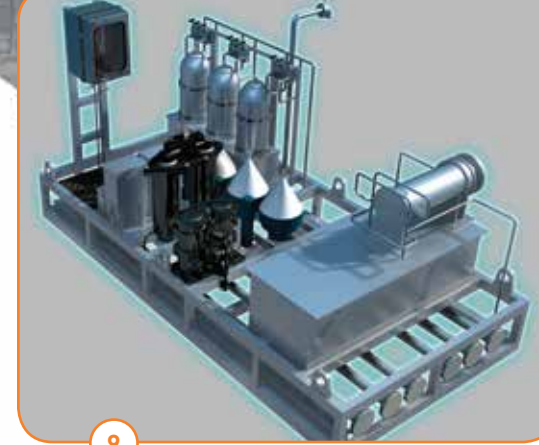

**Liquid fuel filtration**  
Our filtration components purify liquid fuel, removing particulates and water for improved reliability.

## COMBINED CYCLE

# ENGINEERED SOLUTIONS



### >> SMR SYSTEM FOR VARNISH REMOVAL

**Problem:**  
Varnish buildup in hydraulic fluid.

**Solution:**  
SMR (Sub-Micron Removal) off-line filtration system.

**Parker Advantage:**  
Parker's SMR system contains patent-pending Balanced Charge Agglomeration (BCA™) technology to maintain hydraulic and lubricating fluids in optimum condition and prevent/remove the buildup of sludge and varnish.



### >> PVS CART ELIMINATES CONTAMINATION

**Problem:**  
High water and particulate contamination can be devastating to hydraulic and lubrication systems in combined cycle plants, causing component failure, bearing damage, and decreased oil life.

**Solution:**  
PVS portable purification will remove all free water and 90% of dissolved water, gas, and air while removing all solid particulates.

**Parker Advantage:**  
PVS offers a portable, off-line solution to purify hydraulic and lubrication oils with great efficiency. ATEX certification available.



### >> iCOUNT BOTTLE SAMPLER FOR CLEANLINESS MONITORING

**Problem:**  
Critical hydraulic and lubrication systems require continuous monitoring to ensure proper cleanliness levels.

**Solution:**  
Parker's iCOUNT bottle sampler offers continuous monitoring with visual and electrical notification of oil cleanliness levels.

**Parker Advantage:**  
Units are programmable with user ISO cleanliness levels; moisture-sensing technology is available.



### >> A-LOK® TUBE FITTINGS PREVENT CORROSION

**Problem:**  
Two ferrule design fittings with traditional hardening technology susceptible to environmental corrosion.

**Solution:**  
Parker A-LOK® fittings with Supercase.

**Parker Advantage:**  
When hardened with Parker Supercase, A-LOK's rear ferrule resists inter-granular corrosion, creating tube fittings that offer superior sealing and performance in demanding corrosive environments.



### >> STATIONARY OFF-LINE SYSTEM ELIMINATES PARTICULATES IN OIL

**Problem:**  
High levels of particulate and carbon contribute to the degradation of the oil within a load tap changer (LTC) compartment.

**Solution:**  
Stationary Off-line System (SOS).

**Parker Advantage:**  
Parker's SOS unit provides LTCs with clean oil, making full and reliable operation possible.



### >> MULTITUBE® BUNDLES FOR CONTINUOUS EMISSIONS MONITORING (CEMS)

**Problem:**  
Inaccurate emissions reporting to the EPA due to heater cable and tubing failures.

**Solution:**  
Parker's sample transport Multitube® bundles for NO<sub>x</sub>, SO<sub>x</sub>, CO<sub>2</sub>, and mercury.

**Parker Advantage:**  
Multitube bundles offer a consistent temperature accuracy rating of 99% and low/high ambient fluctuation durability to ensure an accurate reading every time.



## FOSSIL FUEL

Parker is proven in the power industry like no other supplier. Our years of technology innovation have created motion and control solutions for applications that range from coal handling to emissions monitoring, and everything in between. Our fluid system solutions are particularly impressive. Whether for hydraulics, hydrogen and air, or high-temperature steam systems, Parker has a vast array of legacy and new performance-enhancing components that improve system life, increase safety, eliminate time and cost, boost efficiency, and accurately meet standards for emissions compliance.

### Multitube® umbilicals offer accurate and reliable mercury monitoring

Coal-fired power plant owners are working hard to find ways to reduce EPA-mandated mercury emissions. Key to the challenge? Accurate, reliable, and cost-effective mercury-monitoring bundles like Parker's Multitube® umbilicals.



Consisting of multiple long lengths of pure fluoropolymer tubing wrapped together with high-temperature heating elements, Multitube umbilicals are used to extract stack gas from a probe located at the top of a smoke stack. The umbilical transports the gas by vacuuming it down to a mercury analyzer, where its mercury content can be verified.

Elevated mercury sample temperatures at the analyzer are critical to achieving quality readings and protecting the analyzer from moisture ingress. Parker's mercury umbilicals maintain a consistent 395°F (202°C) temperature for proper sample transport. In addition, Parker-manufactured tubing offers reduced cost and improved quality. Long-length umbilicals in excess of 1,000 feet are available, and are estimated to save utility companies approximately 35% over conventional bundles. Plus all Parker Multitube bundles meet IEEE specs.

### Phastite® tube connectors minimize MRO downtime

An alternative to welding fittings, Phastite® is a new, push-fit (no ferrule) connector system for pressures up to 20,000 psi (1,379 bar). In providing a permanent, leak-free connection without threaded components, Phastite minimizes MRO downtime. In addition, it eliminates the danger of welding and hot work, and does away with the need for hot work permits.



# Power Source: FOSSIL FUEL

One supplier. Multiple options.

Look to Parker for:

- 1 Oil monitoring and conditioning systems
- 2 Hydraulic system for coal off-loading
- 3 Abrasion-resistant CERGOM 10 hose
- 4 Steam control and instrument racks
- 5 High-pressure pumping systems
- 6 Continuous emission monitoring systems (CEMS)
- 7 Expansion joints

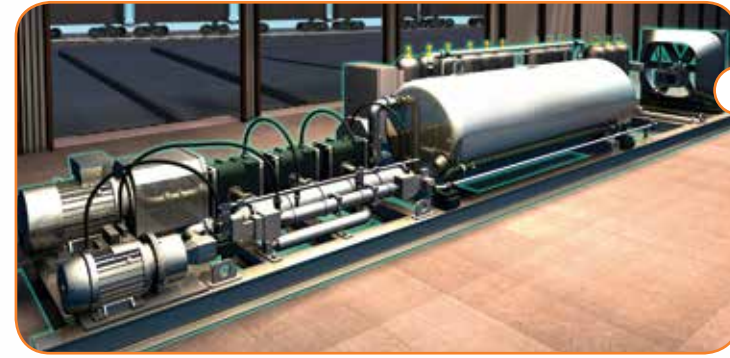

**2 Hydraulic system for coal off-loading**  
A new hydraulic system for coal off-loading provides improved efficiency and faster throughput.



**3 Abrasion-resistant CERGOM 10 hose**  
Our hose offers 34 times the life of steel. Ideal for vacuum conveying systems for coal powders and slurries. Combines a new tube material with ceramic plates embedded in a rubber compound reinforced with a synthetic textile.

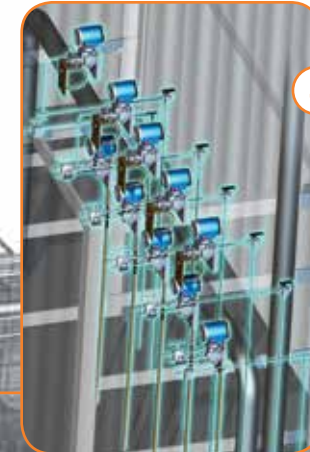

**4 Steam control and instrument racks**  
When used on steam control and instrument racks, Parker MPI™ fittings, valves, and manifolds meet B31.1 certification for the higher temperatures and pressures of supercritical boiler water control.



**5 High-pressure pumping systems**  
Our efficient pumping systems provide accurate flow and high pressure water for flue gas desulphurization systems.



**6 Continuous emission monitoring systems (CEMS)**  
Our control panels, fogging systems, and gas conditioning and delivery systems (sample transport lines, stainless steel pigtailed, high-purity pressure regulators, FRLs, PFA/PTFE fittings and valves, and solenoid valves) provide accurate determination of gas emission levels to ascertain whether the plant is operating within defined control parameters.

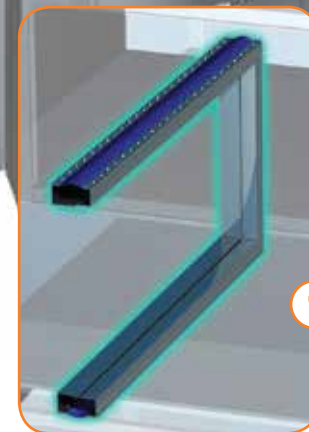

**7 Expansion joints**  
Large flue duct non-metallic expansion joints offer reliable, high-temperature performance from 400°F [204°C] to 2,000°F [1,093°C].

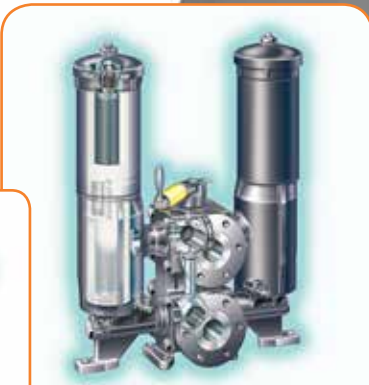

**1 Oil monitoring and conditioning systems**  
Oil monitoring and conditioning systems for steam turbine lubrication and hydraulic systems maintain plant equipment and improve system life.  
*Pictured: icount PD (top); Duplex Filter (center); PVS® unit (right).*



## FOSSIL FUEL

# ENGINEERED SOLUTIONS



### >> MULTITUBE® BUNDLES FOR ACCURATE MERCURY MONITORING

**Problem:** Inaccurate emissions reporting to the EPA due to heater cable and tubing failures.

**Solution:** Parker's mercury-measuring Multitube® bundles.

**Parker Advantage:** Multitube bundles offer a consistent temperature accuracy rating of 99% and low/high ambient fluctuation durability to ensure an accurate reading every time.



### >> ZERO AIR GENERATORS FOR EMISSIONS COMPLIANCE

**Problem:** Hydrocarbon-based impurities in dilution air cause inaccurate reporting.

**Solution:** Parker zero air generators offer safe, reliable gas free of impurities.

**Parker Advantage:** Increases accuracy of analysis while providing long-term cost stability.



### >> CPI™ TUBE FITTINGS RESIST VIBRATION

**Problem:** Tube fittings are susceptible to system vibration and thermocycling.

**Solution:** Parker CPI fittings with Suparcase.

**Parker Advantage:** The single ferrule design of CPI fittings makes them easier to install and offers superior performance in high temperature and high vibration power plant applications.



### >> PAR FIT FOR SINGLE SOURCE FILTRATION

**Problem:** Multiple suppliers for filtration products.

**Solution:** No other company offers more filter types, filter configurations, and filter solutions. Par Fit includes a wide range of hydraulic and lubrication oil filters, reservoirs, and accessories, as well as a wide range of fluid condition monitoring solutions such as in-line and off-line particle measurement systems, moisture detection systems, pressure and temperature measurement systems, and breather elements for both hydraulic and electrical systems.

**Parker Advantage:** Lower cost, simplified billing, streamlined delivery, and enhanced inventory management.



### >> PHASTITE® TUBE CONNECTORS ELIMINATE COST AND TIME OF WELDED FITTINGS

**Problem:** Assembly time for long tubing runs from boiler to water analysis area.

**Solution:** Phastite push-fit (no ferrule) connector system takes only seconds to complete and requires no skilled assembly. What's more, it provides a permanent, leak-free connection without threaded components.

**Parker Advantage:** Reduces both installation time and costs. Eliminates work area and tube/fitting preparation, hot work permits, and equipment placement.



### >> METAL C-SEALS, E-SEALS FOR HIGH-PRESSURE SEALING

**Problem:** Steam turbine casing leakage.

**Solution:** Parker spring-energized metal C-seals and pre-compressed E-seals.

**Parker Advantage:** Parker metal seals use jacket forces, spring forces, and hydrostatic forces to seal the turbine casing with increased force, providing high-pressure capabilities up to 95,000 psi (6,550 bar) with excellent corrosion and fatigue resistance.





## NUCLEAR

Parker manufactures more than 500,000 components to meet the needs of nuclear power generation companies – components that are installed at more than 200 nuclear plants worldwide and offer the efficiency, reliability, and cost effectiveness the industry demands. But we don't stop there. Our multi-million dollar commitment to research and development positions us as the company to partner with. Working hand in hand with you to set the standards and engineer the systems that will shape the future of an increasingly critical power source.

### Label Parker "N" for Necessary

The ASME N Stamp quality certification program is critical to the proliferation of nuclear power worldwide. That's because N Stamp certification is mandatory for plants designed to meet ASME requirements. In addition, Parker meets other international standards for nuclear power plants. These certifications allow Parker to provide a wide variety of products for safety-related and non-safety-related applications.



Parker's Instrumentation Products Division in Huntsville, Alabama received its N Stamp certification for its Class 1, 2, and 3 valves in 2007, making Parker only one of about 100 companies to achieve this higher standard. N Stamps indicate that all aspects of a component, including design, fabrication, and construction, comply with ASME's strict specifications, providing an additional layer of safety to nuclear plant operation.

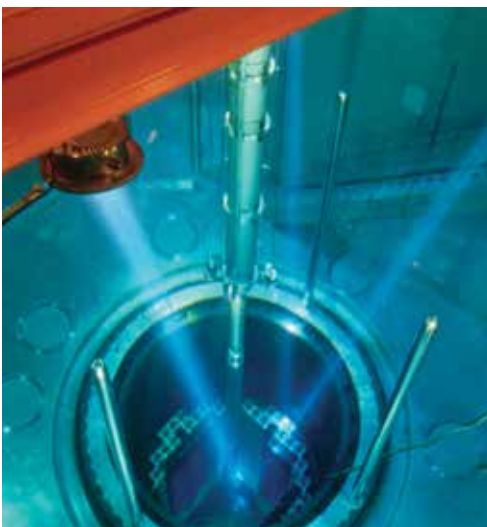

### CPI™ FITTINGS: A long-lasting grip on nuclear innovation

When CPI fittings were designed in 1966, installed tube fittings in nuclear plants were dominated by double ferrule technology – a technology subject to ferrule mixup, ferrule loss, vibration sensitivity and multiple sealing points for multiple leak paths. Parker engineers knew there was a better way. In CPI fittings, they created a unique, interchangeable single ferrule technology that addressed the various drawbacks of a double ferrule design – a technology that evolved with the nuclear market. CPI fittings are just one of the many innovations Parker has brought to the nuclear industry. For more, see the Nuclear Engineered Solutions page.



# Power Source: NUCLEAR

A multi-million dollar commitment to nuclear innovation.

NUCLEAR

ENGINEERED SOLUTIONS

Look to Parker for:

- 1 **CCIMS**
- 2 **Specialty valve systems**
- 3 **Gas spring actuators**
- 4 **Spring-energized metal C-seals**
- 5 **Automated multi-changeout filter system**

**Specialty valve systems**  
Specialty valve systems provide compliance with regulatory issues such as 10CFR50 Appendix B and ASME Section III (safety-related and N Stamp valves), retrofit for legacy equipment (hydraulic servovalves), and alternatives for non-critical systems (solenoid valves).



**Gas spring actuators**  
Used in safety-critical applications to operate main steam isolation, feedwater bypass, and emergency boration valves on pressurized water reactors.

**Spring-energized metal C-seals**  
In steam turbines, Parker metal seals use jacket forces, spring forces, and hydrostatic forces to seal the turbine casing with increased force, providing high-pressure sealing capabilities up to 95,000 psi (6,550 bar) with excellent corrosion and fatigue resistance.

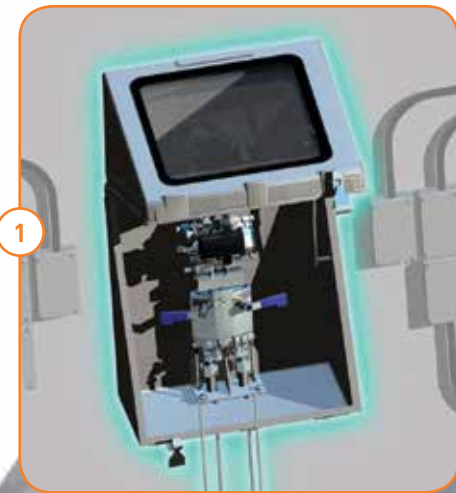

**CCIMS**  
Our integrated manifold solution (CCIMS) offers a precise, high-performance flow measurement and a quick disconnect replacement alternative reducing exposure to radiation. Available in remote and close-coupled mounts.

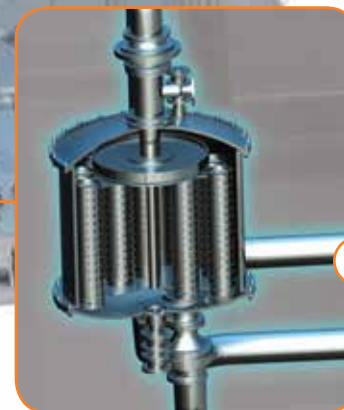

**Automated multi-changeout filter system**  
Automated purification system removes and disposes of the highly radioactive deposits commonly referred to as CRUD that accumulate inside the piping, fuel pools, fuel transfer canals, reactor coolant/feedwater, and other areas of the plant.

## The Parker Nuclear Portal

Our new Nuclear Portal allows Parker to bring a wide range of products from different Parker divisions to the nuclear market under an industry-compliant quality assurance program. The Portal has been developed under Parker Instrumentation's existing NQA-1 and 10CFR50 Appendix B quality assurance programs, and utilizes best practices and guidance from industry and regulatory documents. Current products available through the Parker Nuclear Portal include the following:



### >> PROCESS CONTROL

**Instrument-grade fittings, valves, and manifolds**

Highly engineered process-regulating components and systems designed to increase uptime, maintain safety, and improve production.



### >> FILTRATION

**Filters**

Nuclear-compliant filtration and purification components and systems for industrial process water and more.



### >> FLUID CONTROL & HANDLING

**Hose, quick couplings, and solenoid valves**

A wide range of components and connectors that direct and contain many of the control fluids used in nuclear power generation.



### >> HYDRAULICS & PNEUMATICS

**Actuators, accumulators, and fittings**

Critical technology components that control pressurized fluids and gases to create force and motion throughout nuclear power plants.



### >> SEALING & HANDLING

**Seals and O-rings**

Quality-assured engineered seals and sealing systems provide safety and enhance equipment performance.



### >> ELECTROMECHANICAL

**Servovalves**

Infinitely positionable servovalves offer precise, electrical control of mechanical devices in nuclear power generation for improved productivity.



Parker Hannifin Corporation  
6035 Parkland Blvd.  
Cleveland, Ohio 44124  
phone 800 272 7537  
fax 216 896 4410  
[www.parkerpowergen.com](http://www.parkerpowergen.com)